

VILLATAS



Official Account



SERNTA Website

WWW.VILLATAS.COM

WWW.SERNTA.COM

Agent:
Malaysia
SERNTA Elevator (M) Sdn. Bhd
No.38, Jalan 17/155C, Bandar Bukit Jalil,
57000 Kuala Lumpur, Malaysia
Tel: +60-3-8999-5563/8082-5563
e-mail: my@sernta.com

Philippines
SERNTA Elevator Philippines Inc.
Unit 6B, Marc 2000 Tower,
1973 Taft Avenue, Malate,
Metro Manila, 1004, Philippines
Tel: +63-2-8353-9418
e-mail: ph@sernta.com

Taiwan
SERNTA Elevator Enterprise Co., Ltd.
19F-3, 19F-3, No. 425, Zhonghua Rd.,
Yongkang Dist., Tainan City 710, Taiwan
Tel: +886-6-302-6633
e-mail: ste@sernta.com

THE HOME OF THE

La France

French *style*

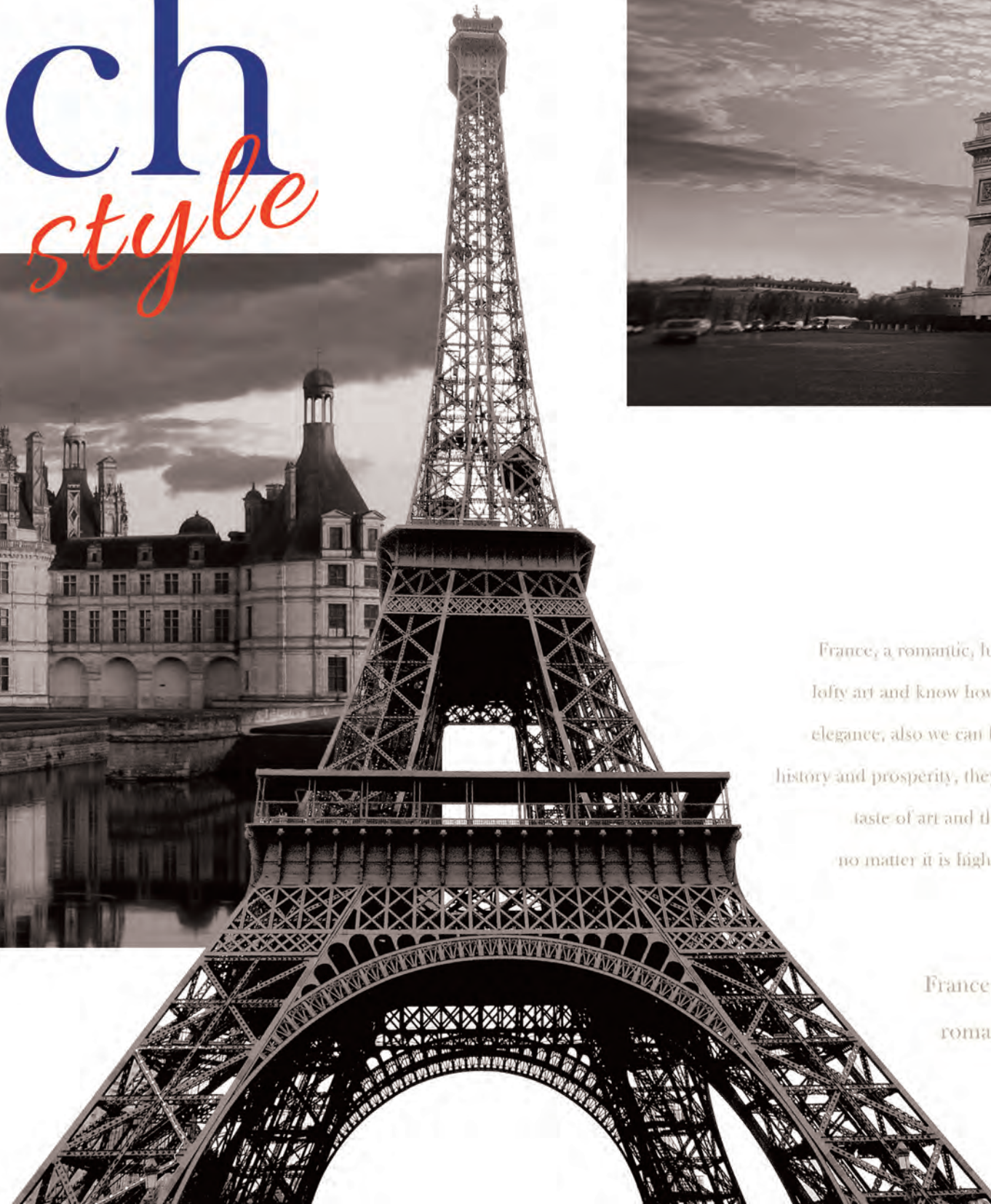

Romantic Luxurious J'aime la France

France, a romantic, luxurious, tasteful and charming country, France is a nation that with lofty art and know how to enjoy the life. Through the artwork, we can see the delicate and elegance; also we can find the aroma of French palace and the romantic life. Experience history and prosperity, they still can treat the life with passionate, keep delicately, enhance the taste of art and the halo of noble from oneself to the life. Even some people say that no matter it is high-profile ostentatious or low-profile luxury, without art, any products can hardly reach the refined tastes.

France, a country famous for its integrated image of beauty and romanticism, fashion and elegance, modernism and tradition.

FRENCH ORIGIN

HOMELIFT



Mr. Patrice Arnoult
CEO
SOMETAS FRANCE

The leader of lift in France



French senior experts



VILLATAS is a joint venture established in China by French senior experts. Through in-depth technical cooperation with SOMETAS company of France, who has more than 40 years of elevator product experience, combined with China's great home lift market demand and strong design & manufacturing capacity, VILLATAS is committed to being the leader of home lift in the global market.



ONLY DESIGN FOR VILLA

Our home lifts offer a unique and elegant combination of Chinese engineering and French design, bringing a safe, high-quality customized solution for your lovely home.

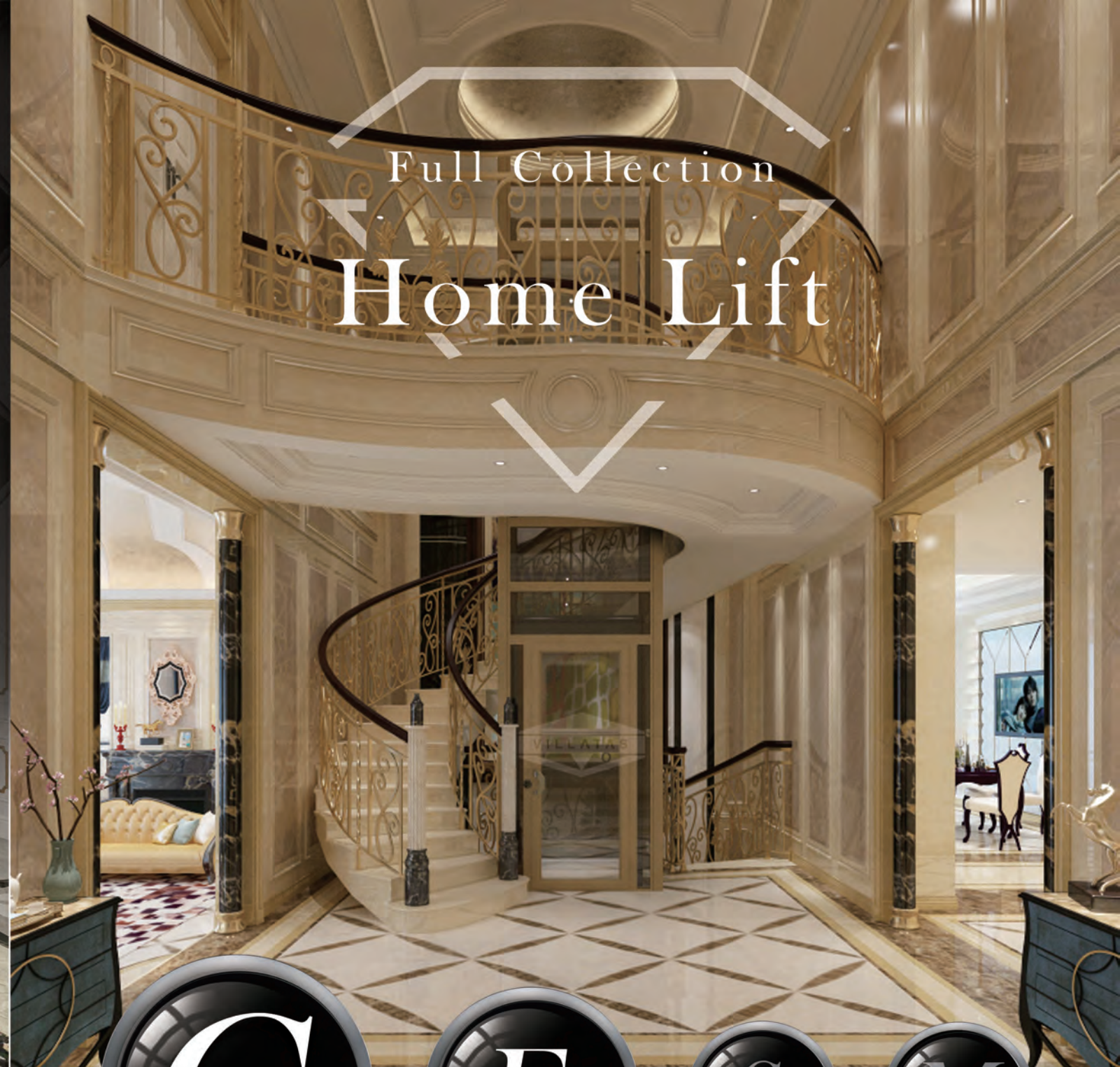

Full Collection
Home Lift

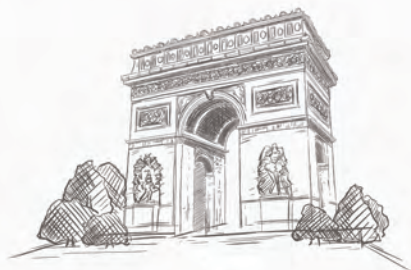

VILLATAS high-end home lift, aims to create unique lift fully with customized solution, humanized function, high-quality technology, to ensure you enjoy a modern and safe way of life.



GLOBAL PUBLISHED

COMING SOON.....

CF100 SERIES
Aluminum Frame Lift

CC100 SERIES
Concrete Shaft Lift



CF110 Swing Door

Mini-space demand, Max-opening
Higher space efficient
Lower noise, Pollution-free

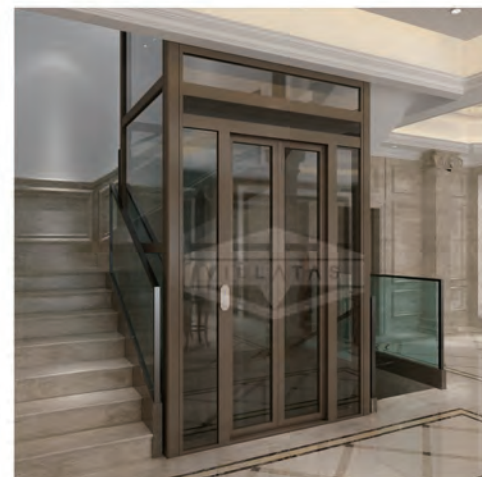

CF120 Center Opening Door

PM Motor, Lower noise
Compact design
Suitable for large shaft and big car size

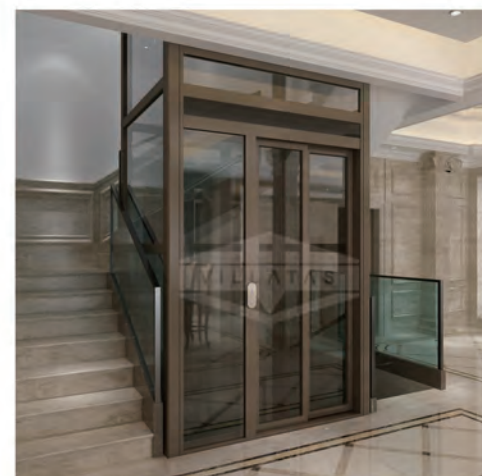

CF130 Side Opening Door

PM Motor, Lower noise
Compact design
Suitable for automatic door requirement
Max-Opening



CC120 Center Opening Door

PM Motor, Lower noise
Compact design
Suitable for large shaft and big car size



CC110 Swing Door

Mini-space demand, Max-opening
Higher space efficient Suitable for
wheelchair user



CC130 Side Opening Door

PM Motor, Lower noise
Compact design
Suitable for automatic door requirement
Max-Opening

INSTALLATION ENVIRONMENT

Be available for different space installation requirement.

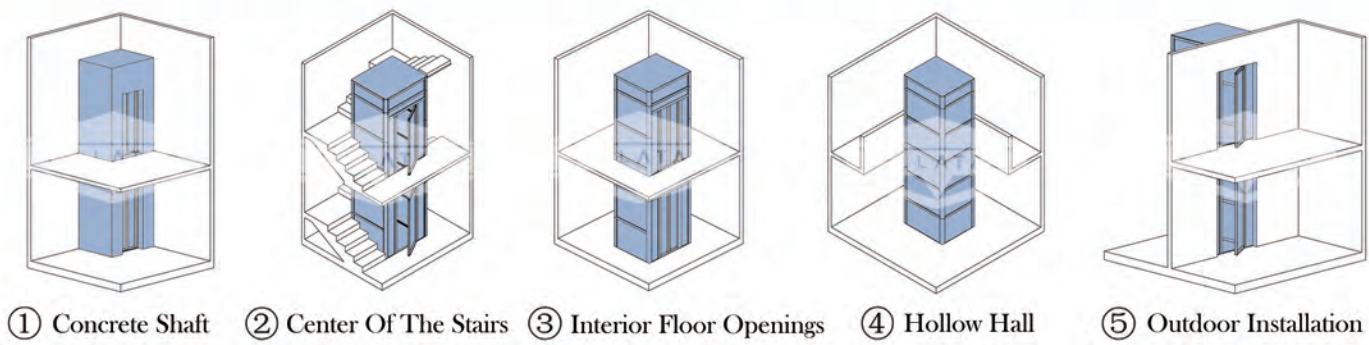

SPACE EFFICIENT

- Maximize Car Size

30% Space efficient created



W/O Counterweight

VS

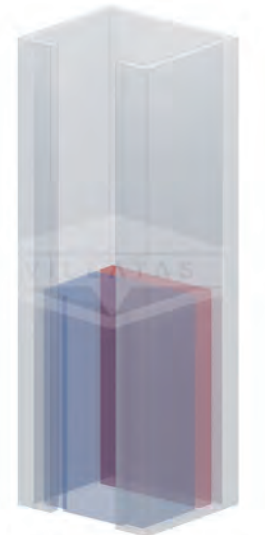

Rear-side Counterweight



Side Counterweight

Notes: Blue is car size
Red is occupied space

- PIT 200mm

SWING DOOR

CC/CF Series



Sandy White VP001



Champagne Gold VP003



Dark Coffee VP004



Classic Black VP005



Matte Grey VP002

Glass Color



Transparent G001



Grey G002

Wooden Panel Color



TB01



TB02



TB03



TB04



TB05

Note: Door frame color is same as Aluminum frame color.
Door glass color is same as frame glass color.
Standard configuration is noted by blue line.

Automatic Door

Observation car

Side Opening

Center Opening



Sandy White VP001



Matte Grey VP002



Sandy White VP001



Matte Grey VP002



Champagne Gold VP003



Dark Coffee VP004



Classic Black VP005



Champagne Gold VP003



Dark Coffee VP004



Classic Black VP005

Glass Color



Transparent G001

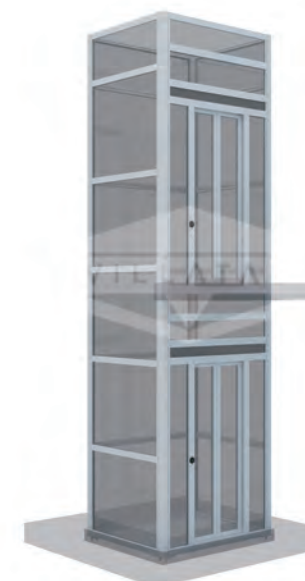

Grey G002

Wooden Panel Color



TB01



TB02



TB03



TB04



TB05

Note: Door frame color is same as Aluminum frame color.
Door glass color is same as frame glass color.

Note: Standard configuration is noted by blue line.

Steel Door Panel Series



Hairline Stainless Steel V-STST01



Etched Stainless Steel V-STST02



Titanium Etched Stainless Steel V-STST03



Rose Gold Etched Stainless Steel V-STST04



Rose Gold Etched Stainless Steel V-STST05



HOME LIFT IoT

i-nest system

Real-Time Monitoring

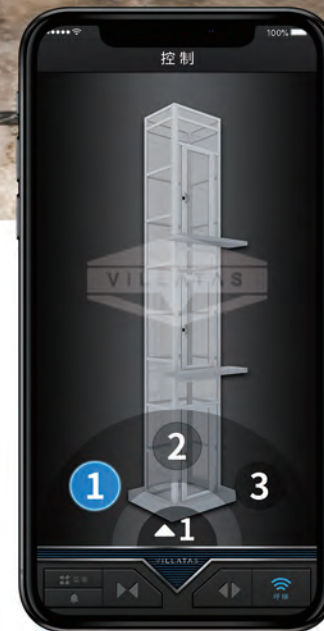

- Real-time check homelift operation status
- Real-time check homelift information
- Remote control homelift
- Check homelift Fault Record
- Check homelift Operation Record

COLORFUL



Classic LOP/Handle

Romantic Classic Luxury



- Indicator: Dark Blue : Normal Status
Light Blue : Calling Landing
Red : Fault Status
- Button: Patented parallel structure; Big size is more convenient for the elder and children; OLED highlight floor display; Failure code display; Logo showing on standby
- European Bronze design, full of luxurious and noble
- Diameter 75 mm

Note: Standard configuration is noted by blue line.

COP

ULTRA-THIN INDUCTION SERIES

ULTRA-THIN TOUCH SERIES



COP-GL-A31

Thickness is only 13 mm, size 500*140*13 mm

- Zinc-alloy frame
Super tempered glass panel
- 7-inch super-large LCD display
Direction indicator Failure code display
- Emergency call button
Make sure that when the elevator fails, people can seek help from outside
- Built-in microphone and speaker to achieve rescue calls
Emergency lighting, provide lighting when power off
- Induction button. Dark blue on standby
brilliant blue on calling

Ultrathin and Full screen Cool and Smart

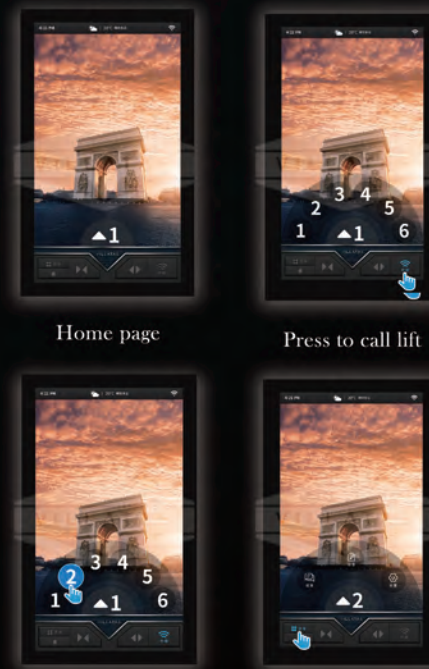

Home page

Press to call lift

Press to choose level

Menu



COP-TOUCH-A11

Blue light of the background



Intelligent Door Handle

The worldwide first intelligent handle,
intelligent technology to ensure safety.

The handle won't appear until
leveling



DK-CR-B10



DK-CR-B12



DK-CR-B14

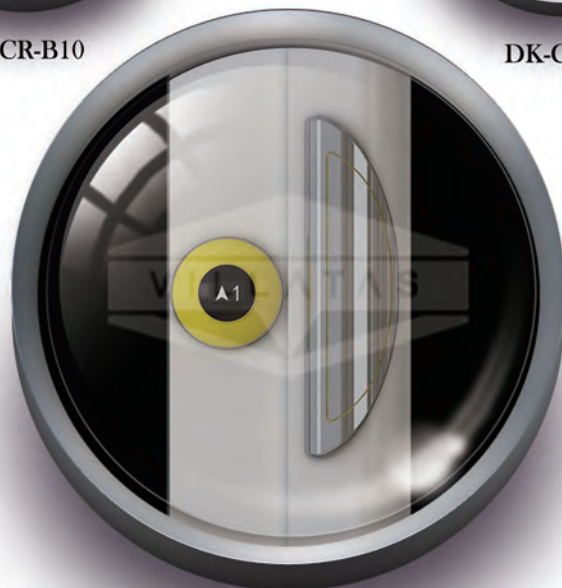

DK-CR-B11



DK-CR-B13



Emergency Rescue of Power Failure

No more fear on power failure



Introduction

- Supply the power immediately on power off
- To ensure user's safety

One-Click Call

No longer trapped due to lift failure and seek help immediately.

Introduction

- When the lift fails to operate, an emergency call page appears in the one-click call system. Passengers can choose to call the preset caller for help until someone answers
- When passengers have an accident in the lift and want to ask for help from outside, they can press the "one-click call" operating system alarm bell to ask for help from outside. The system will automatically call the preset caller or the passengers can choose the caller by themselves

Function Option

Emergency Running Function

Emergency Running Function

- | | |
|--|---------------------------------------|
| Hoistway Self-learning | Position and name record on power off |
| Collective control | Calling cancel in oppsite direction |
| Fault auto- detection function | Repeated closing door |
| Grid power voltage fluctuation detection | Fault data recording |
| Door reopen signal | Parking |
| Auto-leveling after inspection | Non-stop setting |
| Floor position intelligent correction | Input port evaluation |
| One-click call | Running time protection |
| ARD (STD) | |

Operation and Service Function

- | | |
|--|--|
| Auto door opening on leveling | Auto-returning to base floor |
| Open door by door-opening button | Hall position and lift status indicator |
| Pre-close door by door-closing button | Opening/closing door button (Automatic door) |
| Auto energy saving function | Manually floor selection |
| Car position and lift status indicator | Car Fan (STD) |
| Flexiable floor setting | Indicating symbols setting for landing display |
| | I-nest system (Option) |

Control and Safety Protection Function

- | | | |
|--|---|---|
| Inspection running | Protection against safety circuit fault | Main contactor and brake contactor paste protection |
| Door closing time protection | Relay checking protection | Alarm and lighting on power off |
| Door light curtain protection | Limiting protection | Door closing protection against obstruction |
| Emergency electrical running of car top and controller | Up and down limiting protection device | Manual operation priority on top of car |
| Speed feedback inspection | Brake inspection protection | Door lock short circuit protection |
| Buffer on pit | Motor overheat protection | |
| Protection against door-opening outside door zones | Rope over-rolling protection | |
| Electrical brake release | Reversing protection | |
| Pre-torque output | Contactor feedback inspection | |
| Speed changing on terminal and stop; Floor number adjust | By-passing on full load | |
| Low speed self-rescue function on fault | Overload without door closing and alarm | |



INTELLIGENT
EMERGENCY SYSTEM



CAR DECORATION

VILLATAS attaches great importance to the spaciousness and comfort, offering a variety of car decorations and high-quality customization.

LUXURY ROMANTIC
HOMELIFT



FASHION CLASSICAL

FASHION CLASSIC



VL001
 CEILING : Ceil01-V1 FLOOR : VStone01
 CAR PANEL: TB01 HANDLE: VHR01



LED light on the top



With decoration

COMFORT SERIES

Observation Car



VL002
 CEILING : Ceil01-V2 FLOOR : VStone01
 CAR PANEL: TB02 HANDLE: VHR01



VL003
 CEILING : Ceil01-V3 FLOOR : VStone02
 CAR PANEL: TB03 HANDLE: VHR01



VL004
 CEILING : Ceil01-V4 FLOOR : VStone03
 CAR PANEL: TB04 HANDLE: VHR01



VL005
 CEILING : Ceil01-V5 FLOOR : VStone04
 CAR PANEL: TB05 HANDLE: VHR01



■ Marble Floor (free option)

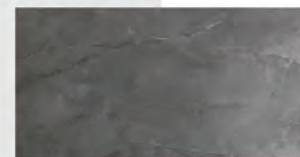

VStone01



VStone02



VStone03



VStone04

Note: Standard configuration is noted by blue line.



VW001

CEILING : Ceil01-V1
CAR PANEL: TB01

FLOOR : VStone01
HANDLE: VHR01

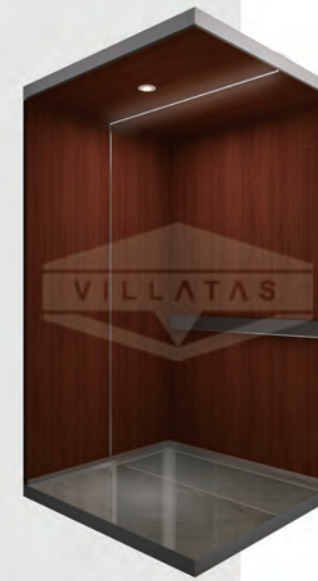

VW002

CEILING : Ceil01-V2
CAR PANEL: TB02

FLOOR : VStone01
HANDLE: VHR01



VW003

CEILING : Ceil01-V3
CAR PANEL: TB03

FLOOR : VStone02
HANDLE: VHR01



VW004

CEILING : Ceil01-V4
CAR PANEL: TB04

FLOOR : VStone03
HANDLE: VHR01



VW005

CEILING : Ceil01-V5
CAR PANEL: TB05

FLOOR : VStone04
HANDLE: VHR01



LED light on the top



With decoration

■ Marble Floor (free option)

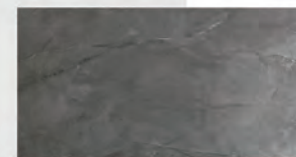

VStone01



VStone02

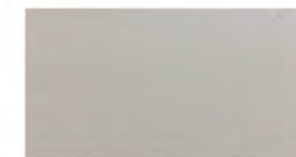

VStone03



VStone04

Note: Standard configuration is noted by blue line.



VLL001
 CEILING : Ceil02-V1
 CAR PANEL: TB01
 FLOOR : VStone01+VStone02
 HANDLE: VHR04



VLL002
 CEILING : Ceil02-V2
 CAR PANEL: TB02



FLOOR : VStone01+VStone04
 HANDLE: VHR04



VLL003
 CEILING : Ceil02-V3
 CAR PANEL: TB03



FLOOR : VStone01+VStone03
 HANDLE: VHR04



VLL004
 CEILING : Ceil02-V4
 CAR PANEL: TB04



FLOOR : VStone01+VStone02
 HANDLE: VHR04



VLL005
 CEILING : Ceil02-V5
 CAR PANEL: TB05



FLOOR : VStone01+VStone04
 HANDLE: VHR04



LED light on the top and side



Double match

■ Double-color marble floor (VStone 01+ free option)

Back

Front

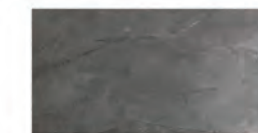
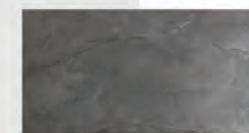

VStone01

VStone01

VStone02

VStone03

VStone04



VWL001

CEILING : Ceil02-V1
CAR PANEL: TB01

FLOOR : VStone01+VStone02
HANDLE: VHR04



VWL002

CEILING : Ceil02-V2
CAR PANEL: TB02

FLOOR : VStone01+VStone04
HANDLE: VHR04



VWL003

CEILING : Ceil02-V3
CAR PANEL: TB03

FLOOR : VStone01+VStone03
HANDLE: VHR04



VWL004

CEILING : Ceil02-V4
CAR PANEL: TB04

FLOOR : VStone01+VStone02
HANDLE: VHR04



VWL005

CEILING : Ceil02-V5
CAR PANEL: TB05

FLOOR : VStone01+VStone04
HANDLE: VHR04



LED light on the top and side



Double match

■ Double-color marble floor (VStone 01+ free option)

Back

Front

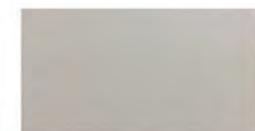
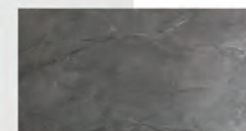

VStone01

VStone01

VStone02

VStone03

VStone04

COLORFUL SERIES Observation Car

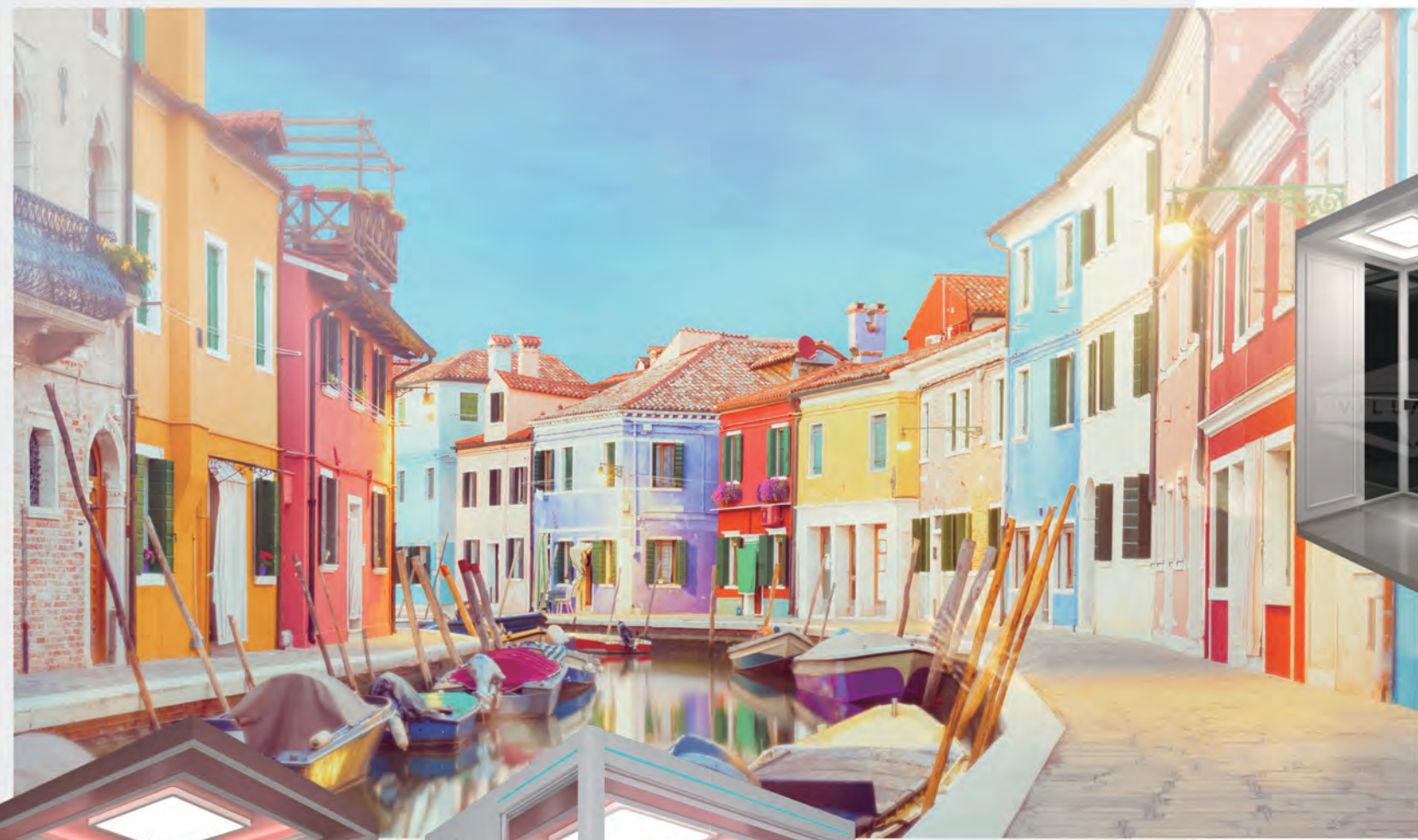

VCL001
CEILING : Ceil03-V1
HANDLE : VHR02
FLOOR : VStone01(Front)+VStone03(Back)

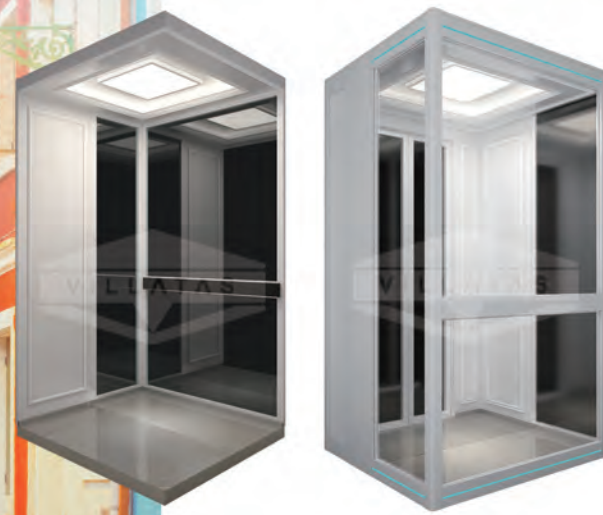

VCL002
CEILING : Ceil03-V2
HANDLE : VHR02
FLOOR : VStone04(Front)+VStone03(Back)

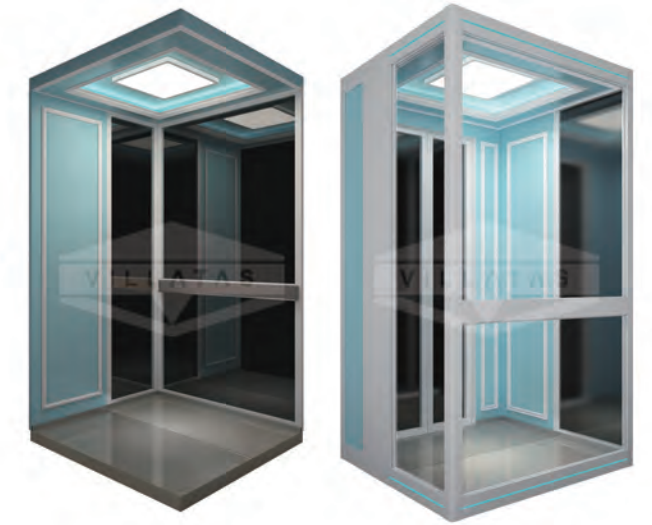

VCL003
CEILING : Ceil03-V3
HANDLE : VHR01
FLOOR : VStone04(Front)+VStone02(Back)

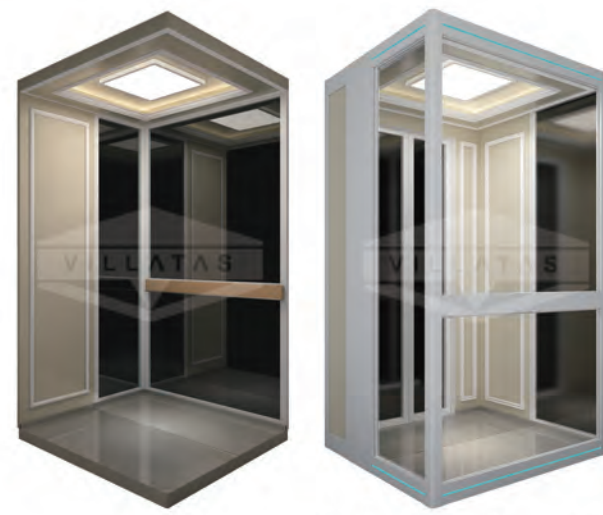

VCL004
CEILING : Ceil03-V4
HANDLE : VHR02
FLOOR : VStone04(Front)+VStone02(Back)

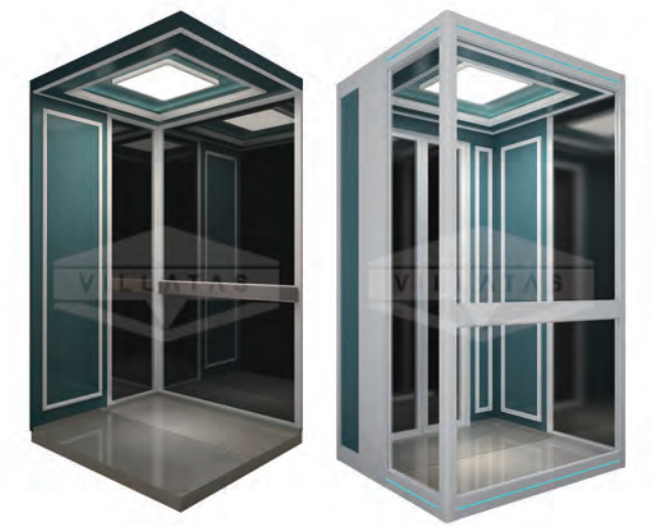

VCL005
CEILING : Ceil03-V5
HANDLE : VHR03
FLOOR : VStone02(Front)+VStone03(Back)

■ Marble Floor (free option)

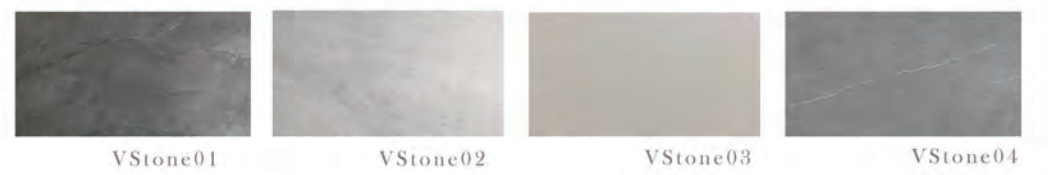

COLORFUL SERIES Non-observation car



VCW001
 CEILING : Ceil03-V1
 HANDLE : VHR02
 FLOOR : VStone01(Front)+VStone03(Back)



VCW002
 CEILING : Ceil03-V2
 HANDLE : VHR02
 FLOOR : VStone04(Front)+VStone03(Back)



VCW003
 CEILING : Ceil03-V3
 HANDLE : VHR01
 FLOOR : VStone04(Front)+VStone02(Back)



VCW004
 CEILING : Ceil03-V4
 HANDLE : VHR02
 FLOOR : VStone04(Front)+VStone02(Back)

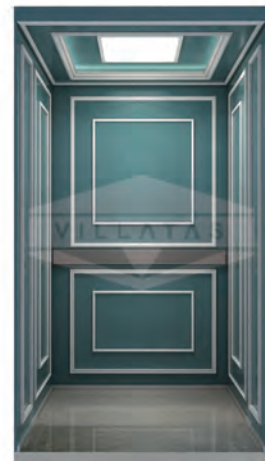

VCW005
 CEILING : Ceil03-V5
 HANDLE : VHR03
 FLOOR : VStone02(Front)+VStone03(Back)

■ Marble Floor (free option)



VStone01



VStone02



VStone03



VStone04





HONOR001
 CEILING : Ceil04-V1 FLOOR : VStone05
 CAR PANEL: wood+relief HANDLE: VHR03

**HONOR
 SERIES**
 Non-observation Car



HONOR002
 CEILING : Ceil04-V2 FLOOR : VStone05
 CAR PANEL: wood+relief HANDLE: VHR03

Made in France

IMPORT



All Import
 Component configuration, Arbitrary choice

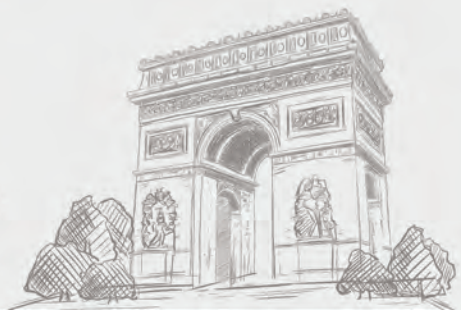

Swing Door CC110

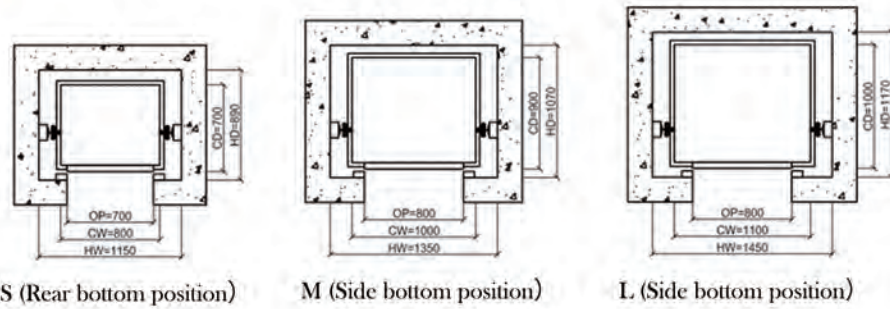

Center Opening Door CC120

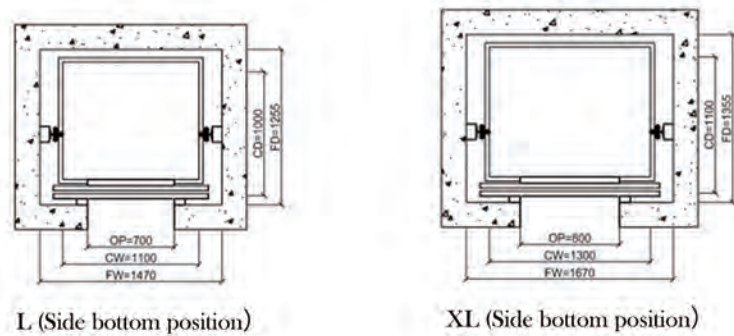

Side Opening Door CC130

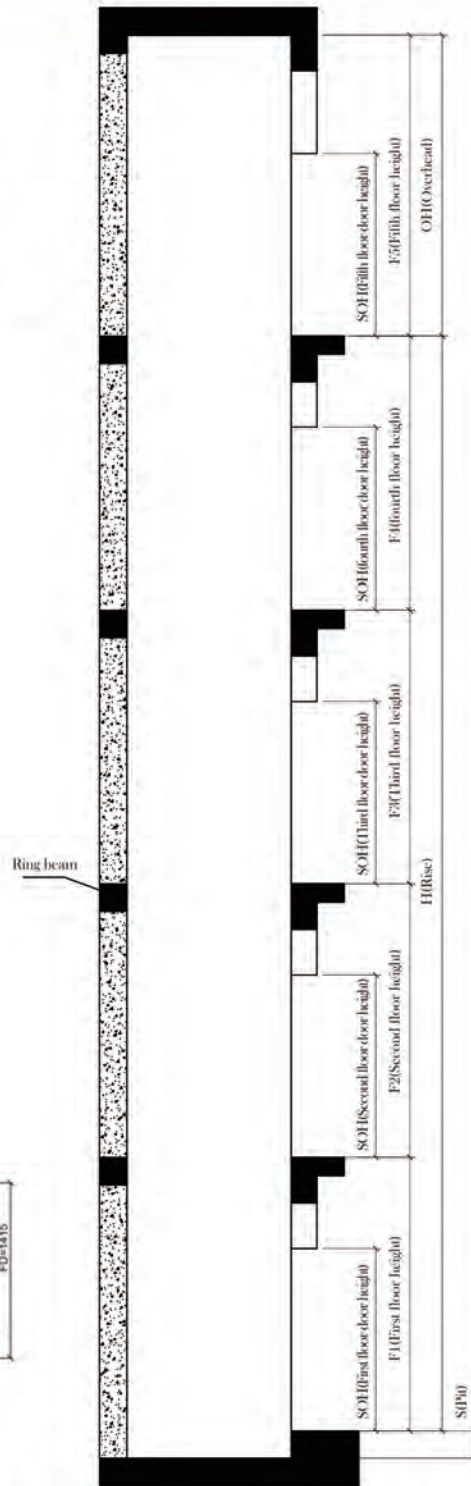
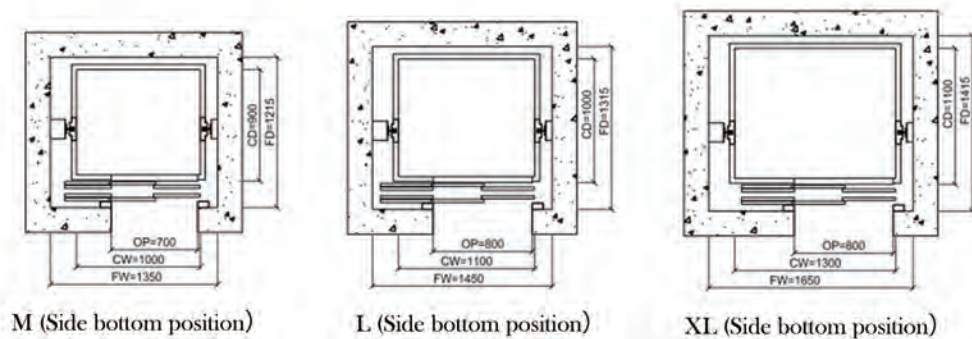

Model	CC110					CC120				CC130					
Shaft type	Concrete														
Opening type	Swing door(Handle on the right,open the door to the right)					Center opening door				Side opening door					
NO.	1	2	3	4	5	6	7	8	9	10	11	12	13	14	15
Person	3	3-4		4-5		4-5		5-6		3-4		4-5		5-6	
Area(m ²)	S	M		L		L		XL		M		L		XL	
	0.5-0.7	0.7-0.9		0.9-1.2		0.9-1.2		1.2-1.6		0.7-0.9		0.9-1.2		1.2-1.6	
Car width (CW)	800	1000		1100		1100		1300		1000		1100		1300	
Car depth (CD)	700	900		1000		1000		1100		900		1000		1100	
Car high (CH)	2100														
Door opening width(OP)	700	800				700	800				700	800			
Door opening height(OPH)	2000														
Machine position (ML)	Rear	Side	Rear	Side	Rear	Side	Rear	Side	Rear	Side	Rear	Side	Rear	Side	Rear
Shaft width (HW)	1150	1350	1350	1450	1450	1470	1470	1670	1670	1350	1350	1450	1450	1650	1650
Shaft depth (HD)	890	1070	1090	1170	1190	1255	1275	1355	1375	1215	1235	1315	1335	1415	1435
Pit(S)	200														

Note: All unlabeled dimensions are in millimeters

Swing Door CF110

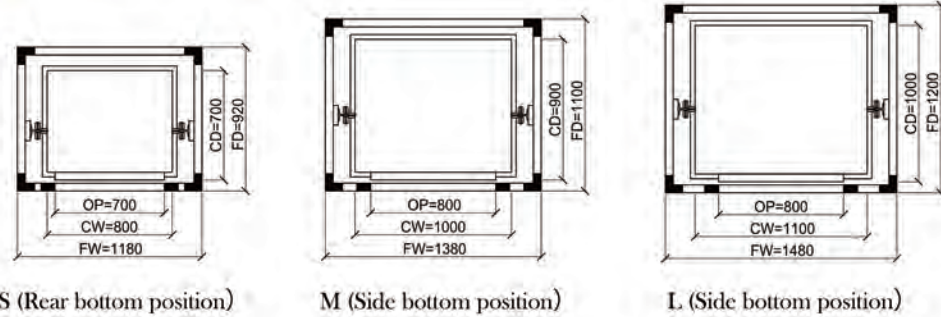

Center Opening Door CF120

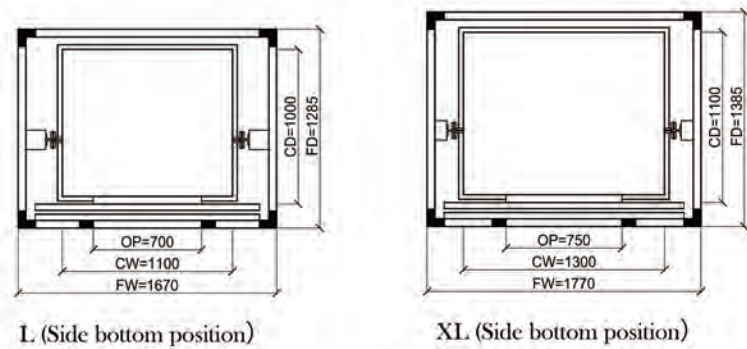

Side Opening Door CF130

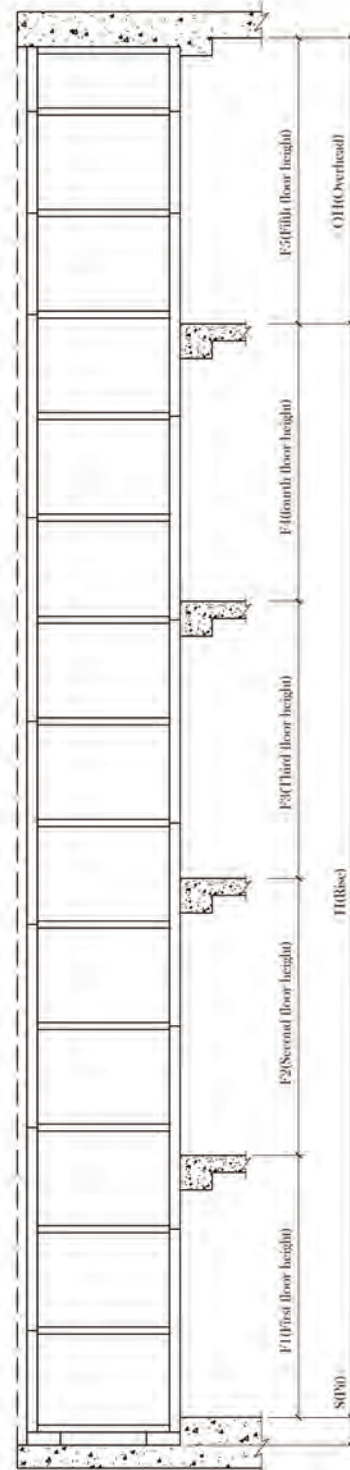
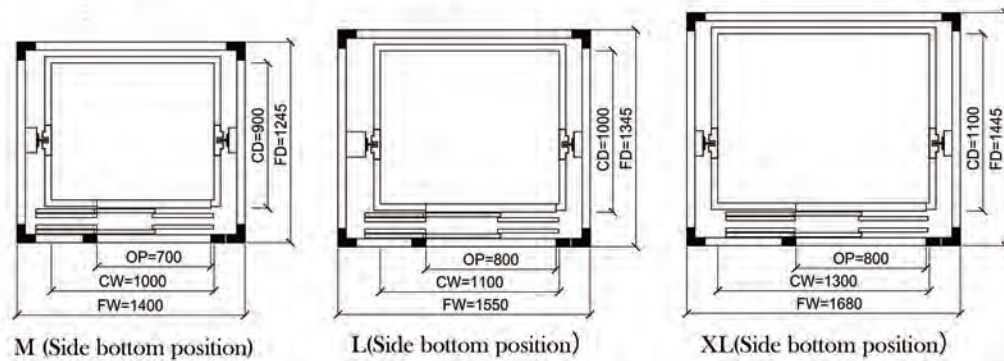

Model	CF110					CF120				CF130						
Shaft type	Aluminum frame															
Opening type	Swing door(Handle on the right,open the door to the right)					Center opening door				Side opening door						
NO.	1	2	3	4	5	6	7	8	9	10	11	12	13	14	15	
Person	3		3-4		4-5		4-5		5-6		3-4		4-5		5-6	
Area(m ²)	S	M		L		L		XL		M		L		XL		
	0.5-0.7		0.7-0.9		0.9-1.2		0.9-1.2		1.2-1.6		0.7-0.9		0.9-1.2		1.2-1.6	
Car width (CW)	800	1000		1100		1100		1300		1000		1100		1300		
Car depth (CD)	700	900		1000		1000		1100		900		1000		1100		
Car high (CH)	2100															
Door opening width(OP)	700	800				700	750		700		800					
Door opening height(OPH)	2000															
Machine position (ML)	Rear	Side	Rear	Side	Rear	Side	Rear	Side	Rear	Side	Rear	Side	Rear	Side	Rear	
Frame width (FW)	1180	1380	1380	1480	1480	1670	1670	1770	1770	1400	1400	1550	1550	1680	1680	
Frame depth (FD)	920	1100	1120	1200	1220	1285	1305	1385	1405	1245	1265	1345	1365	1445	1465	
Shaft width (HW)	1200	1400	1400	1500	1500	1690	1690	1790	1790	1420	1420	1570	1570	1700	1700	
Shaft depth (HD)	930	1110	1130	1210	1230	1295	1315	1395	1415	1255	1275	1355	1375	1455	1475	
Pit(S)	200															

Note: All unlabeled dimensions are in millimeters